



802373

01/10

Küchenmischer
Mitigeur de cuisine
Miscelatore da cucina
Mezclador de cocina
Kitchen faucet

Montage- und Serviceanleitung
Instructions de montage et d'entretien
Istruzioni di montaggio e di assistenza
Instrucciones de montaje y servicio
Installation and service instructions

KWC AVA

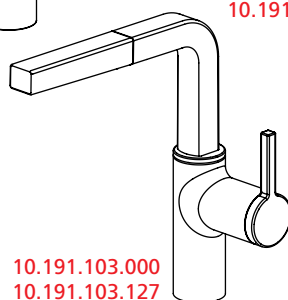
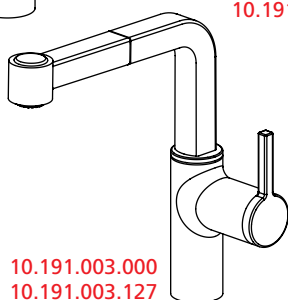
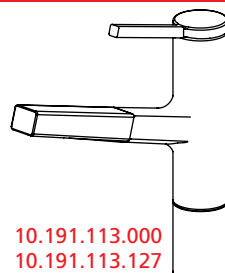
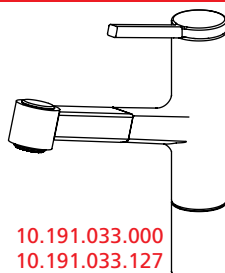
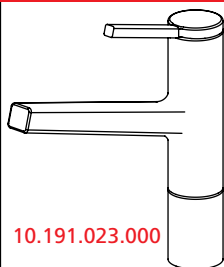

Schweiz, Suisse:
KWC AG
Hauptstrasse 57
5726 Unterkulm

Tel.: 062 768 68 68
Fax: 062 768 61 62

Oesterreich:
Hansa Austria GmbH
Rottfeld 7
5020 Salzburg

Tel: 0662 433 100
Fax: 0662 433 100 20

Deutschland:
KWC Deutschland GmbH
Sigmaringer Strasse 107
70567 Stuttgart

Tel: 0711 49 08 39-0
Fax: 0711 49 08 39-30

USA:
KWC Faucets Inc.
1770 Corporate Drive #580
Norcross, Georgia 30093

Phone: 678 334 2121
Fax: 678 334 2128

Italia:
KWC Italia S.r.l.
Via A. Meucci 54
36057 Arcugnano (VI)

Tel: 0 44 496 48 20
Fax: 0 44 496 47 35



France:
Hansa France
Rue Ettore Bugatti
67038 Strasbourg-Cedex2

Tél: 03 88 78 88 08
Fax: 03 88 76 55 32

Recyclingpapier auf 100% Altpapierbasis.
Papier de recyclage sur 100% bases de vieux papier.
Riciclaggio della carta sulla base della carta straccia di 100%.
Reciclaje del documento sobre base del papel usado del 100%.
Recycling paper on 100% waste paper basis.

Betriebsdaten**Caractéristiques de fonctionnement****Caratteristiche di funzionamento****Datos de servicio****Operating data**

Idealer Betriebsdruck : 3 bar
 Max. Betriebsdruck : 5 bar
 Druckgleichheit empfehlenswert.
 Ideale Wassertemperatur : 60 °C
 Max. Wassertemperatur : 80 °C

Presión ideal de servicio : 3 bar
 Presión máxima de servicio : 5 bar
 Se recomienda la igualdad de las presiones.
 Temperatura ideal del agua : 60 °C
 Temperatura máxima del agua : 80 °C



Achtung:
 Vor Montage die Leitungen gründlich durchspülen!



Atención:
 Enjuagar escrupulosamente las tuberías antes del montaje!

Weitere Informationen finden Sie in unseren detaillierten Verkaufsunterlagen.

Información más detallada en nuestra documentación de ventas.

Pressione di servizio ideale : 3 bar
 Pressione di servizio mass. : 5 bar
 Si raccomanda pressioni uguali.
 Temperatura acqua calda ideale : 60°C
 Temperatura acqua calda mass. : 80°C

Ideal operating pressure : 3 bar (45 PSI)
 Max. operating pressure : 5 bar (70 PSI)
 Equal pressures are recommended.
 Ideal water temperature : 60 °C (140°F)
 Max. water temperature : 80 °C (180°F)



Attenzione:
 Risciacquare bene le tubazioni prima del montaggio!



Attention:
 Flush pipes thoroughly before installation!

Ulteriori informazioni le troverete nelle nostre dettagliate documentazioni.

For further information refer to our detailed sales literature.

Pression de service idéale : 3 bar
 Pression de service max. : 5 bar
 Egalité de pression recommandée.
 Température idéale de l'eau : 60°C
 Température max. de l'eau : 80°C



Attention:
 Rincer à fond la tuyauterie avant le montage!

Pour informations supplémentaires voir nos documentations de vente détaillées.



- D Schäden, die infolge unsachgemässer Behandlung, natürlicher Abnutzung oder zu grosser Inanspruchnahme entstanden sind, sind von unseren Garantieleistungen ausgeschlossen!
- F Ces dommages survenus en raison d'un traitement inadéquat, des signes d'usure traitement inadéquat, naturels ou du grand utilisation, sont exclus de notre garantie.
- I Danni ai rubinetti, conseguenti da un trattamento non appropriato, sono esclusi dalla nostra garanzia!
- Sp Daños, debidos a un tratamiento inadecuado, son excluidos de la nuestra garantía.
- E Damages on the faucet resulting from incorrect handling are excluded from the manufacturers warranty!

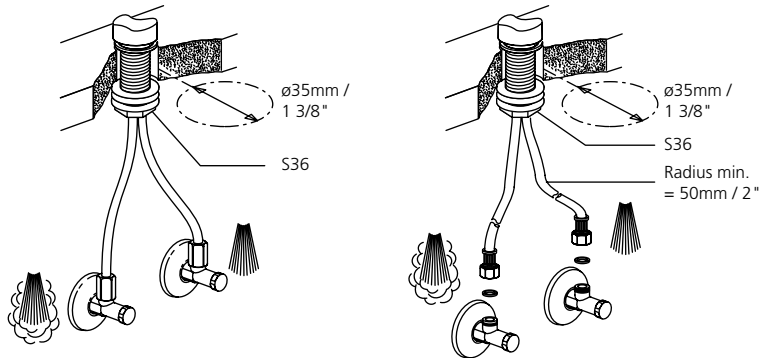

Montage des Schlauchstop's
Montage du stop
Montagio del stop
Montaje del stop
Installation of limit stop

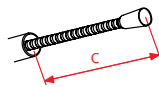

$c = 700\text{ mm} / 27\ 9/16''$

$d = 500\text{ mm} / 19\ 11/16''$

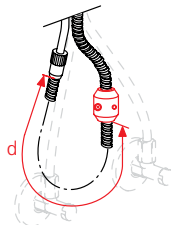

Inbetriebsetzung
Mise en service
Messa in funzione
Puesta en servicio
Initial operation

1

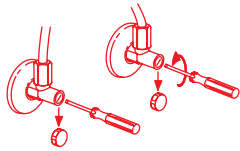

Kalt- und Warmwasser öffnen.

Ouvrir eau froide et chaude.

Aprire acqua fredda e calda.

Abrir la salida de agua fría y caliente.

Open cold and hot water.

2

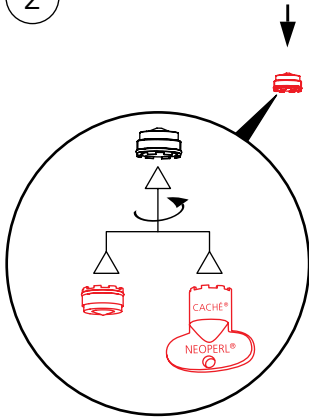

3

||||||| D spülen
||||||| F rincer
||||||| I sciacquate
||||||| Sp enjuagar
||||||| E flush

4



2

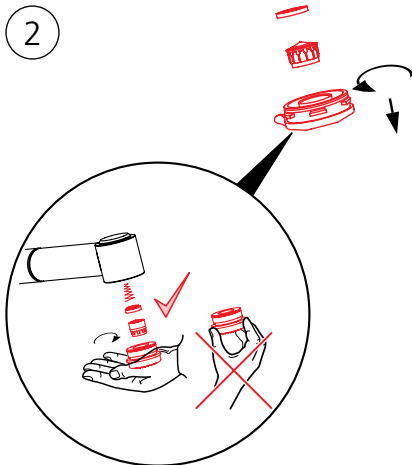

3

||||||| D spülen
||||||| F rincer
||||||| I sciacquate
||||||| Sp enjuagar
||||||| E flush

4

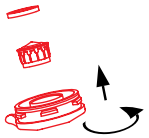

Ersatzteile
Pièces de rechange
Pezzi di ricambio
Repuestos
Spare parts

10.191.033.000
10.191.033.127
10.191.113.000
10.191.113.127

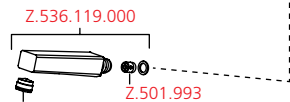
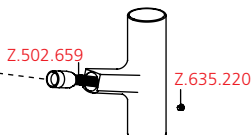
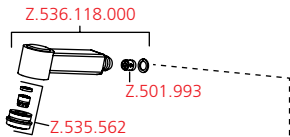
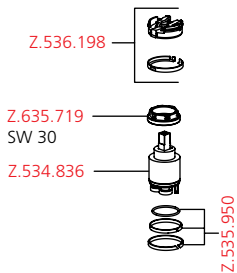
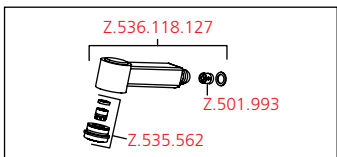
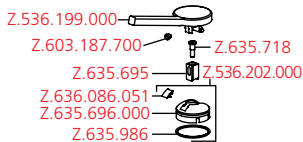
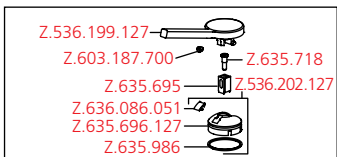

Z.635.143
M18,5 x1

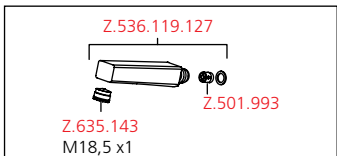
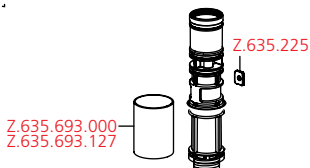

Z.635.143
M18,5 x1

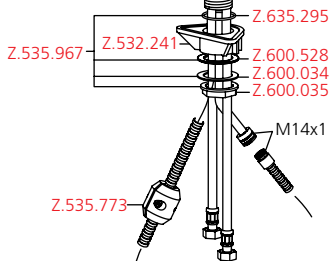
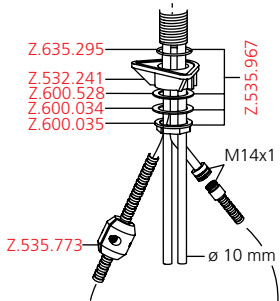

USA/CAN:

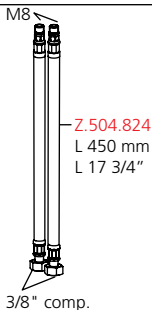

M8

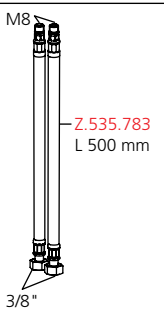

USA/CAN:

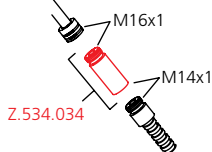

Backflow prevention (1x) and flow regulator in adapter.

10.191.023.000

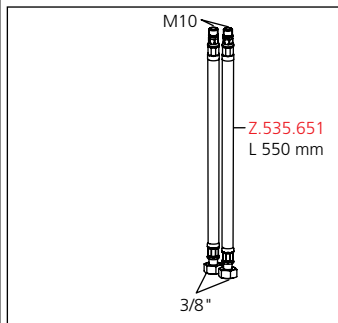
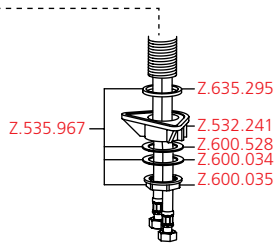
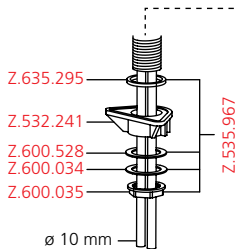
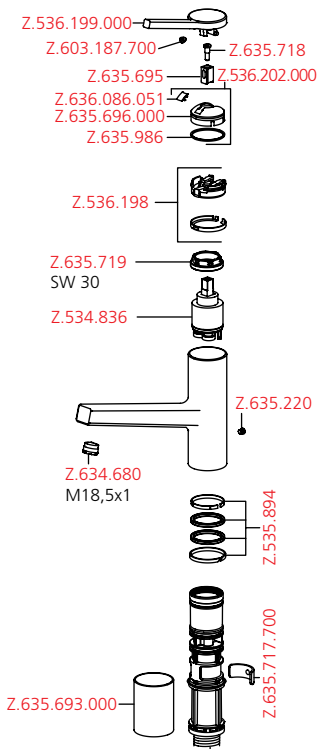

M18.5x1
 Z.634.729

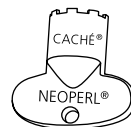

Ersatzteile
Pièces de rechange
Pezzi di ricambio
Repuestos
Spare parts

10.191.003.000
10.191.003.127
10.191.103.000
10.191.103.127

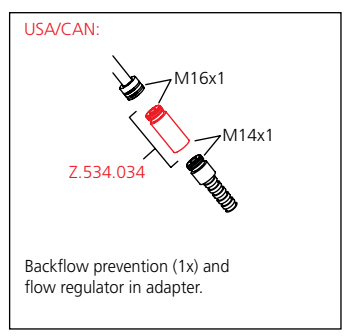
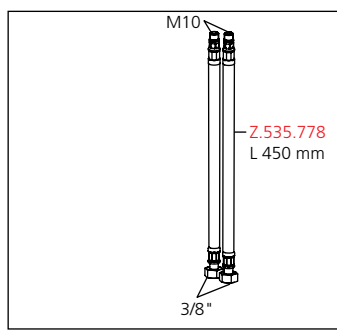
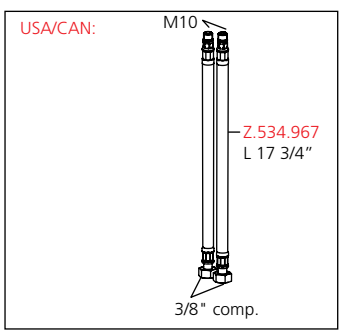
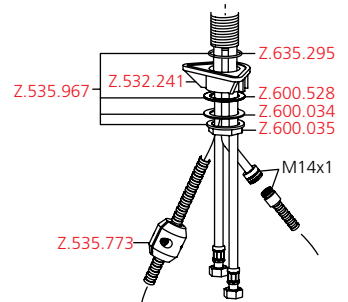
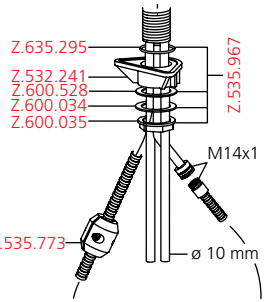
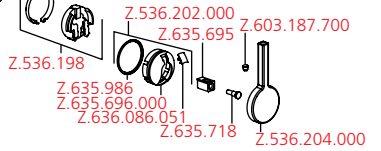
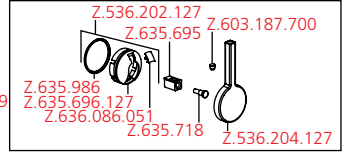
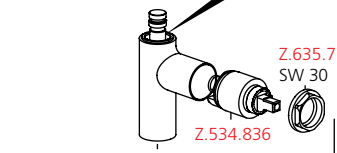
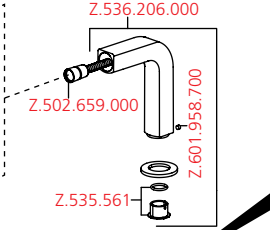
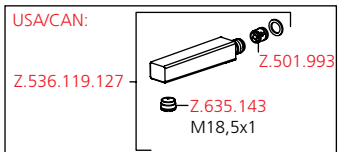
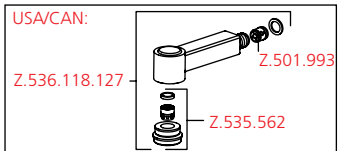
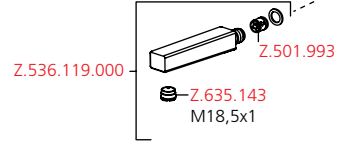
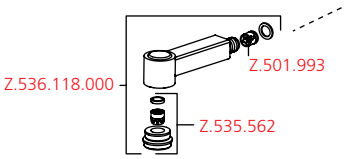
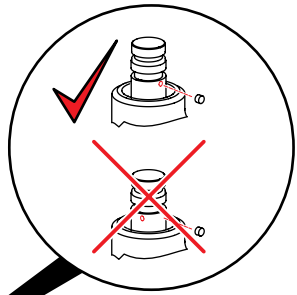
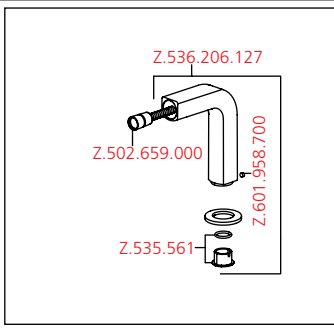

Pflegeanleitung für Armaturen und Zubehör
Instruction pour la maintenance des robinets et des accessoires
Istruzioni per la manutenzione di rubinetti e accessori
Instrucciones para el cuidado de griferías y accesorios
Maintenance / Cleaning instructions for faucets and accessories

Grundsätzliche Reinigungshinweise:

- Beim Reinigen muss die Oberfläche der Armatur kalt sein (Wärme beschleunigt die Zerstörung der Oberfläche)!

- Reinigungshinweise der Reinigungsmittelhersteller beachten!

Die Pflege:

- Armatur täglich mit weichem Lappen trocken reiben!
- Scheuernde Reinigungsmittel und Putzschwämme unbedingt vermeiden!

Die Reinigung:

- Schmutz- oder Kalkflecken auf der Armaturenoberfläche nur mit mildem Reinigungsmittel entfernen!
- Sofort nach dem Reinigen alle Reinigungsmittelrückstände mit kaltem Wasser wegspülen!
- Mit weichem Lappen trocken reiben.

Instructions principales pour le nettoyage:

- Durant le nettoyage, la surface du robinet doit être froide (la chaleur accélère l'usure de la surface)!
- Nous vous prions de faire attention aux indications mentionnées sur les nettoyages!
- Assurez vous que les produits ne contiennent pas d'acides ou des substances corrosives.

L'entretien:

- Le robinet doit être nettoyé chaque jour avec un chiffon mou.
- Evitez absolument l'usage des brillants pour métaux, éponges abrasives ou produits similaires!

Le nettoyage:

- Enlevez saïssures et dépôts calcaires de la surface du robinet seulement avec des produits qui ne sont pas agressifs!
- Immédiatement après le nettoyage, rincer bien les résidus des détergents avec de l'eau froid!
- Sécher avec un chiffon mou.

Principali istruzioni per la pulizia:

- Durante la pulizia, la superficie del rubinetto deve essere fredda (il calore accelera il logorio della superficie)!
- Fare attenzione alle indicazioni riportate sui prodotti per la pulizia!
- Accertarsi che non contengano acidi o sostanze corrosive.

La manutenzione:

- Il rubinetto deve essere asciugato quotidianamente con un panno morbido.
- Evitare assolutamente paglietta, spugne abrasive o similari!

La pulizia:

- Togliere sporco e calcare dalla superficie del rubinetto solo con detersivi non aggressivi!
- Subito dopo la pulizia, sciacquare bene i residui di detersivo con acqua fredda!
- Asciugare con un panno morbido.

Avisos básicos de limpieza:

- Cuando se procede a limpiar la grifería, su superficie debe estar fría (el calor acelera la destrucción de la superficie)!

- Respetar los avisos de limpieza del fabricante del detergente!

Cuidado:

- Secar la grifería frotando diariamente con un paño blando!
- Evite, imprescindiblemente, detergentes y esponjas de limpieza raspantes!

Limpieza:

- Quitar las manchas de suciedad o cal en la superficie de la grifería sólo con un detergente poco agresivo!
- Inmediatamente después de la limpieza eliminar, enjuagando con agua fría, todos los residuos del detergente!
- Secar frotando con un paño blando.

In General:

- Faucet surface must be of room temperature before cleaning (elevated temperature increases damage of the surface).
- Cleaning instructions of the detergent manufacturer must be followed.

Maintenance:

- Rub the faucet daily dry with a soft cloth.
- Never use corrosive cleaners or cleaning pads.

Cleaning:

- Dirt or calcareous deposits on the faucet surface must be removed with soft detergent or with soap water!
- Rinse well with water immediately after cleaning (make sure that no detergent remains on the surface)
- Dry with soft cloth.



- D Schäden, die infolge unsachgemässer Behandlung, natürlicher Abnutzung oder zu grosser Inanspruchnahme entstanden sind, sind von unseren Garantieleistungen ausgeschlossen!
- F Ces dommages survenus en raison d'un traitement inadéquat, des signes d'usure traitement inadéquat, naturels ou du grand utilisation, sont exclus de notre garantie.
- I Danni ai rubinetti, conseguenti da un trattamento non appropriato, sono esclusi dalla nostra garanzia!
- Sp Daños, debidos a un tratamiento inadecuado, son excluidos de la nuestra garantía.
- E Damages on the faucet resulting from incorrect handling are excluded from the manufacturers warranty!